



Better Tanks

BT INDIRECT SERIES WATER HEATERS

BTI 30, BTI 40, BTI 55, BTI 65, BTI 80, BTI 80-MAX, BTI 119-MAX

FOR SINGLE WATER HEATER INSTALLATIONS



CAUTION

- 1. The heat transfer-medium must be water or other nontoxic fluid having a toxicity rating or Class of 1, as listed in Clinical Toxicology of Commercial Products, 5th edition.**
- 2. The pressure of the heat transfer medium must be limited to a maximum of 30 PSIG by an approved safety or relief valve.**

For service or repairs to the water heater, call your heating contractor. Your water heater has been manufactured to provide years of service. In order to insure proper service, the following information is provided to assist in enabling the installation, operation, and maintenance of this water heater. When the installation is completed, keep this manual with the water heater.

Product complies with NSF/ANSI 372 and conforms with lead content requirement for “lead-free” plumbing as defined by the California, Vermont, Maryland and Louisiana state laws and the U.S. Safe Drinking Water Act in effect as of January 4, 2014.



Intertek

Conforms to NSF / ANSI Std. 372

HAZARDS & PRECAUTIONS

DANGER

Points out an immediately hazardous situation which must be avoided in order to prevent serious injury or death.

WARNING

Points out a potentially hazardous situation which must be avoided to prevent serious injury or death.

CAUTION

Points out a potentially hazardous situation which must be avoided to prevent possible moderate injury and/or property damage

NOTE

Points out installation, maintenance and operation details that will result in enhanced efficiency, longevity and proper operation of your boiler.

IMPORTANT SAFETY INSTRUCTIONS

Failure to read and comply with all instructions and applicable National and local codes may result in hazardous conditions that could result in property damage and injury to occupants which in extreme cases might result in death.

When using electrical appliances, basic safety precautions to reduce the risk of fire, electric shock, or injury to persons should be followed, including:

READ ALL INSTRUCTIONS BEFORE USING THIS WATER HEATER

1. Install or locate this water heater only in accordance with the provided installation instructions
2. Use this water heater only for its intended use as described in this manual.
3. As with any appliance, close supervision is necessary when used by children.
4. Do not operate this water heater if it is not working properly, or if it has been damaged or dropped.
5. Installation, start-up and servicing of IBC Indirect Water Heaters must be done with due care and attention, and should only be performed by competent, qualified, licensed and trained plumbing and heating technicians. Contact nearest authorized service facility for examination, repair, or adjustment.

SAVE THESE INSTRUCTIONS NEAR THE WATER HEATER FOR FUTURE REFERENCE

Included with Water Heater:

- Aquastat
- 10KΩ Sensor
- Instruction Manual

Not Included:

- Temperature and Pressure Relief Valve
- Tank Drain Valve

CONTENTS

1.0	GENERAL INFORMATION	4
2.0	PRE-INSTALLATION CONSIDERATIONS	6
2.1	Supplied with this Water Heater	6
2.2	Important considerations Before Installation	6
2.3	System Zone Control	6
2.4	Priority or Non-Priority for Hot Water	7
2.5	Locating the Water Heater	7
2.6	Temperature and Pressure Relief Valve	8
2.7	Additional Recommended Components	8
2.8	Removing the Existing Domestic Water Heating System	8
2.9	Water Quality	9
3.0	PIPING	10
3.1	Domestic Water Piping	10
3.2	Boiler Water Piping	10
3.3	Zone Circulator System	10
3.4	Zone Valve System	11
4.0	ELECTRICAL	12
4.1	Temperature Sensor	12
4.2	Aquastat	13
5.0	OPERATION	14
5.1	Startup	14
5.2	Temperature Adjustment	14
6.0	MAINTENANCE	15
6.1	Chemical Cleaning of the Heating Coil	15
7.0	TROUBLESHOOTING	16
8.0	SCHEMATICS	17

1.0 GENERAL INFORMATION

NOTE

The instructions in this manual focus almost entirely on installations where the IBC water heater is used in conjunction with a compatible IBC Boiler. It is necessary for the Installer and Designer to read the IBC Boiler manuals and application notes, to ensure that finished installations will operate in harmony and deliver optimal energy savings and efficiency.

IBC water heaters are compatible with most other boiler makes, and can be an excellent choice, but Installers and Designers must tailor their designs to the specific control, operational and installation requirements of any alternate Boiler.

NOTE

This equipment shall be installed in accordance with those installation regulations required in the area where the installation is to be made. These regulations shall be carefully followed in all cases. Authorities having jurisdiction shall be consulted before the installations are made.

All wiring on water heaters shall be in accordance with the National Electrical Code and/or local regulations.

CAUTION

Installation, start-up and servicing of IBC boilers and Water Heaters must be done with due care and attention, and should only be performed by competent, qualified, licensed and trained heating technicians.

WARNING

Improper installation, adjustment, alteration, service or maintenance can cause property damage, personal injury, or loss of life. Read and understand the entire manual before attempting installation, start-up, operation, or service. Installation and service must be performed only by an experienced, skilled installer or service agency.

This water heater contains very hot water under high pressure. Do not unscrew any pipe fittings or attempt to disconnect any components of this water heater without positively assuring that the water is cool and has no pressure. Always wear protective clothing and equipment when installing, starting up or servicing this water heater to prevent scalding injuries. Do not rely on the pressure and temperature gauges to determine the temperature and pressure of the water heater. This water heater contains components that become very hot when the boiler is operating. Do not touch any components unless they are cool.

Failure to follow all instructions in the proper order can cause personal injury or death. Read all instructions, including all those contained in component manufacturers' manuals before installing, starting up, operating, maintaining, or servicing the water heater.

CAUTION

To reduce the risk of excessive pressures and temperatures in this water heater, install temperature and pressure protective equipment required by local codes but no less than a combination temperature relief valve certified by a nationally recognized testing laboratory that maintains periodic inspection of production of listed equipment or materials, as meeting the requirements for Relief Valves and Automatic Shutoff Devices for Hot Water Supply Systems, ANSI Z21.22-latest edition. This valve must be marked with a maximum set pressure not to exceed the marked working pressure of the water heater. Install the valve into an opening provide and marked for this purpose in the water heater, and orient it or provide tubing so that any discharge from the valve will exit only within 6 inches above, or at any distance below, the structural floor, and cannot contact any live electrical part. The discharge opening must not be blocked or reduced in size under any circumstances.

The heat transfer medium must be water or other non-toxic fluid having a toxicity rating or class of 1, as listed in clinical Toxicology of Commercial Products, latest edition.

The pressure of the heat transfer medium must be limited to the maximum of 30 psi.

DANGER

DO NOT store or use gasoline or other flammable vapors or liquids in the vicinity of this or any other appliance.

If you smell gas vapors, **DO NOT** try to operate any appliance - **DO NOT** touch any electrical switch or use any phone in the building. Immediately, call the gas supplier from a remote located phone. Follow the gas supplier's instructions or if the supplier is unavailable, contact the fire department.

MODEL	TANK CAPACITY	DIMENSIONS		PIPING CONNECTIONS NPT		REGULATION CONNECTION	RELIEF VALVE CONNECTION	APPROX. SHIPPING WEIGHT
	USG	HEIGHT INCHS	DIAMETER INCHES	DOMESTIC WATER IN/OUT INCHES	BOILER WATER IN/OUT	INCHES	INCHES	LBS
BTI 30	26.7	39.6	20.0	3/4	1	N/A	3/4	50.7
BTI 40	39.9	47.0	21.4	3/4	1	N/A	3/4	66.2
BTI 55	56.5	62.8	21.4	3/4	1	N/A	3/4	91.5
BTI 65	64.5	70.3	21.4	3/4	1	N/A	3/4	97.5
BTI 80	79.9	70.0	23.8	1	1-1/2	3/4	3/4	118.0
BTI 80-MAX	79.9	70.0	23.8	1	1-1/2	3/4	1	141.1
BTI 119-MAX	114.6	65.75	28.9	1-1/2	1-1/2	3/4	1	177.5

Table 1: Dimensions and Capacities. Maximum Allowable Working Pressure – 150 psi, Hydrostatically tested to 300 psi.

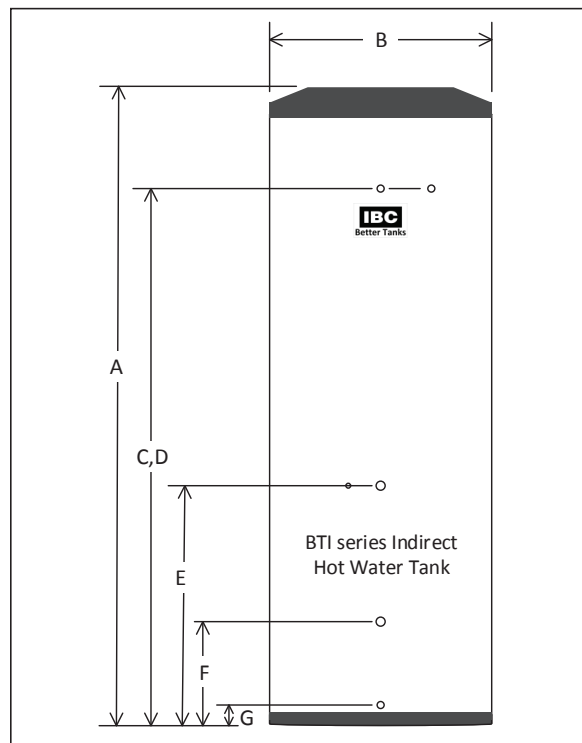

Figure 1: Standard Unit - Dimensions and Connections

MODEL	MAX. FIRST HOUR RATING US GAL/HR @ 135°F	CONTINUOUS RATING US GAL/HR @ 135°F	BOILER OUTPUT REQUIRED BTU/HR	BOILER WATER FLOW GPM	PRESSURE DROP THROUGH COIL (FT. WATER)
BASED ON 180°F BOILER SUPPLY AND 58°F ENTERING COLD WATER					
BTI 30	159	137	88,000	8	3
BTI 40	188	156	100,000	8	3
BTI 55	200	156	100,000	8	3
BTI 65	325	269	172,000	13	4
BTI 80	239	171	109,000	10	3
BTI 80-MAX	453	393	251,000	15	7
BTI 119-MAX	482	393	251,000	15	7

Table 2: Ratings

2.0 PRE-INSTALLATION CONSIDERATIONS

⚠ NOTE

BT Indirect Series water heaters come with a 10KΩ sensor and a standard aquastat. The aquastat can be used to create a call for heat with most any boiler manufacturers boiler (relays may be required in some cases). The 10KΩ sensor will work with all IBC boilers and may also be compatible with some of the other boiler manufacturers. Ensure compatibility if using the sensor with other boiler manufacturers equipment.

⚠ NOTE

There are a number of jurisdictional issues that may prevent this water heater from being accepted by local Inspection Authorities. Issues such as double-wall heat exchanger requirements, local or State registration requirements, may cause an installation to be rejected.

It is essential that the Installer check with local Officials to ensure acceptance of this equipment prior to the installation.

IBC will not accept liability for any of these situations, although we will assist in any way we can, in order to help gain acceptance.

2.1 Supplied with this Water Heater

The IBC Water Heater is shipped with the following items:

- Aquastat
- 10KΩ Sensor
- Instruction Manual

Not Included:

- Temperature and Pressure Relief Valve
- Tank Drain Valve

Inspect shipment carefully for signs of damage. All equipment is carefully inspected and packed. IBC's responsibility ceases upon delivery of the water heater to the carrier in good condition. Any claims for damage or shortage, must be filed immediately against the carrier by the consignee. No claims for variances or shortages will be allowed by the Manufacturer, unless they are presented within 7 days after receipt of the equipment.

Installation must conform to the requirements of the authority having jurisdiction. In the absence of such requirements, it must conform to the National Plumbing Code and the National Electrical Code ANSI/NFPA No. 70, current edition.

2.2 Important Considerations Before Installation

- 1. Water heater sizing.** Choose the water heater model based on the expected water usage for the given site. The average residence with one shower or more will require a Model 40 or larger. Factors that increase water demand dramatically include high flow shower heads, hot tubs, and the use of more than one shower at a time. Increase the tank size if these factors are present. Carefully review the IBC Water Heater specifications contained herein, and consult ASHRAE sizing guides and other reliable references. Dimensions, weights, ratings, and capacities are outlined in Tables 1 and 2.
- 2. Boiler sizing.** The water heater will provide the rated performance only if it is used with a boiler with a heating capacity of at least as much as the capacity ratings in Table 2. If the boiler has less capacity, the water heating output will be reduced.
- 3. Circulator sizing.** Refer to Table 2 for the flow through the water heater coil and the pressure drop at minimum flow. Calculate the pressure drop across all piping and fittings connected to the water heater zone. Be sure to include all zone valves, check valves, and shut-off valves. It is recommended that the water heater zone be piped with minimum 1" pipe around the entire loop on typical residential sites.

2.3 System Zone Control

The water heater must be installed as a separate zone from the space heating system. The water heating zone's piping and circulator must be sized for the minimum flow rate with all the zones in use and a maximum flow with only the water heater in use. This is the reason that the best method of zone control is with circulators. The three most common systems are:

- 1. Zone Circulators.** The space heating zones use a circulator for each zone, and the water heater is controlled with an additional circulator.

⚠ CAUTION

To avoid water damage from leaks, a drain pan should be installed under the water heater unless it is installed in a location where leaks will not cause property damage. See Figure 6: Suggested Domestic Water Piping.

If the discharge from a T&P relief valve cannot be directed into a drain or to an area where water damage will not occur, a drain pan capable of draining away the full, continuous discharge flow of the relief valve should be installed.

⚠ WARNING

During operation, the T&P relief valve may discharge large amounts of steam and/or hot water. Therefore, to reduce the potential for bodily injury and property damage, a discharge line **MUST** be installed that it:

1. is connected from the valve outlet with no intervening valve and directed downward to a safe point of discharge.
2. allows complete drainage of both the valve and the discharge line.
3. is independently supported and securely anchored so as to avoid applied stress on the valve.
4. is as short and straight as possible.
5. terminates freely to atmosphere where any discharge will be clearly visible and is at no risk of freezing.
6. terminates with a plain end which is not threaded.
7. is constructed of a material suitable for exposure to temperatures of 375°F or greater.
8. is, over its entire length, of a pipe size equal to or greater than that of the valve outlet.

DO NOT CAP, PLUG OR OTHERWISE OBSTRUCT THE DISCHARGE PIPE OUTLET!

2. **Hybrid System.** The space heating zones use zone valves for each zone, and the water heater is controlled with an additional circulator. See Section 8.0, Figure 2: Generic Boiler Piping Schematic – Zoned by Circulator.
3. **Zone Valves.** The space heating zones use zone valves for each zone, and the water heater is controlled with an additional zone valve. Select a valve with a low pressure drop, and adequate pipe size to assure minimum flow.

2.4 Priority or Non-Priority for Hot Water

OPTION 1 – PRIORITY

The demand for space heating is interrupted until the hot water demand is satisfied. This option provides the maximum delivery of hot water. IBC boilers are easily configured to operate the Hot Water as a priority load. Priority is recommended when:

1. The boiler output is less than 100,000 Btu per hour, or
2. The boiler output required to satisfy the hot water demand is more than 50% of the boiler output needed to satisfy the space heating demand, or
3. When an interruption in space heating can be tolerated during long domestic hot water draws.

The preferred strategy when using Priority is to use a dedicated load circulator for domestic hot water generation. In most cases the delay in space heating will not be noticed because of the rapid recovery of the water heater.

OPTION 2 – NON-PRIORITY

The boiler output is divided between space heating and water heating. Heating of domestic hot water can be reduced during simultaneous space and water heating demands. The maximum amount of reduction depends on the boiler output, the number of space heating zones calling, the space heating target water temperature, and the amount of boiler water flow split between the space heating and zones and the water heater zone.

2.5 Locating the Water Heater

The water heater should be located in an area where water leakage from the tank or connections will not result in damage to areas adjacent to the water heater or to lower floors of the structure. When such a location can not be avoided, a suitable drain pan must be installed under the water heater, and the drain pan must be connected to a drain.

The water heater should be installed as close to the boiler as is practical for easy access for service. The unit is designed for installation on combustible flooring and in alcoves, closets, etc.

SURFACE	DISTANCE FROM COMBUSTIBLES	FOR SERVICE
Front	1"	24"
Rear, Right and Left Sides	1"	1"
Top	1"	1"
Bottom	0"	0"

Table 3: Clearances from heater jacket

⚠ WARNING

There are a number of conditions, including improper control settings, which could result in elevated tank temperatures from ANY type of water heater. An overheating hazard can result, potentially causing serious personal injury and/or property damage.

IBC recommends as a *minimum* precaution, the installation of a point of source ASSE 1017 approved thermostatic mixing valve on the outlet of the water heater. Local jurisdictions may require more comprehensive protective measures depending on the place of installation (ie. schools, nursing homes, etc.). Check with local Authorities for direction.

⚠ CAUTION

When removing any fuel burning appliance from a common venting system, the opening must be properly sealed off and; if there are remaining appliances still using the common venting system, the vent must be examined to ensure that it is not over-sized as a result of having removed the old water heater.

⚠ CAUTION

Do not operate the IBC water heaters in areas where the pH is above 8.0 or below 6.0, and/or with chloride concentrations greater than 80 parts per million (ppm). IBC's standard warranty does not cover problems caused by improper water pH or excessive levels of chlorides.

2.6 Temperature and Pressure Relief Valve

1. Supply a Temperature and Pressure Relief Valve rated to ANSI Z21.22 and that has a rating greater than the gross input of the boiler connected to the water heater.
2. Install the Temperature and Pressure Relief Valve in the tapping located at the top of the tank and labeled Relief Valve.
3. Pipe the outlet of the relief valve to an appropriate location (Floor Drain or Drain Pan) terminating within 6" of an appropriate drain location. Pipe the relief valve piping down toward the outlet of the piping so that the piping and the valve can fully drain. Never terminate the relief valve piping outdoors where it may freeze.
4. Do NOT install a shut off valve between the water tank and the relief valve. Do NOT plug the outlet of the relief valve.

2.7 Additional Recommended Components

1. Shut-off valves. Allows the isolation of the water heater from the boiler system during service.
2. Tank drain valve. Installed at the bottom of the water heater to allow for servicing and draining of the water heater.
3. Unions. Allows for easy locating or removal.
4. Vacuum breaker. Protects the water heater from collapse if a hot tank is valved off to service other components in the system.
5. Thermal expansion tank. If the water heater is installed in a closed water supply system, such as a system having a back flow preventer in the cold water supply line, the installation of a thermal expansion tank is required.
6. Refer to Figure 6 in this manual for suggested external components.

2.8 Removing the Existing Domestic Water Heating System

If the IBC water heater is being installed in an older hydronic system that does not use an IBC boiler:

- **External Tankless Heater.** Disconnect all lines to the boiler and plug the boiler fittings. Disconnect the external heater from the boiler piping, and the domestic piping systems.
- **Internal Tankless Heaters.** Disconnect the domestic piping. Do not plug the cold water or the hot water fittings in the internal tankless coil. Leave the coil in the boiler with the cold and hot water fittings open to prevent pressure build-up in the coil.

If the IBC water heater is being installed to replace an electric or direct fired gas or oil water heater: Disconnect the water piping and either strip back to the nearest main line and cap off, or re-use for the new tank, whichever is appropriate.

- **Electric Water Heater.** Disconnect the electrical supply wiring and remove back to the breaker panel or terminate in an approved junction box. Work must conform to all applicable electrical codes.
- **Direct Fired Gas Water Heater.** Disconnect the gas supply line to the heater, strip back to the nearest mains piping and cap off. Remove vent connector back to the common venting system and seal off or abandon as applicable. Work must conform to all applicable codes.

- **Direct Fired Oil Water Heater.** Disconnect the oil supply line to the heater, strip back to the tank or nearest mains piping and cap off. If oil heating system is to be abandoned completely, ensure proper removal and disposal of old oil tank and remaining fuel oil. Remove vent connector back to the common venting system and seal off or abandon as applicable. Work must conform to all applicable codes.

2.9 Water Quality

Improper water quality will reduce the expected life of the water heater. Hard water, sediment, high or low pH, and high levels of chlorides in the domestic water should be avoided. Sediment and hard water will eventually coat the heating coil inside the water heater and reduce the rate of hot water production and may, eventually cause a failure. High or low Ph and/or high chloride concentrations will cause corrosion and eventually failure. A filter is strongly recommended where sediment is present in the water. A water softening system is recommended for areas with hard water. In an area where the water quality is not known, a water quality test should be performed.

3.0 PIPING

NOTE

Installers should inquire of local water purveyors as to the suitability of their supply for use in hydronic heating systems.

If water quality is questionable, a local water treatment expert must be consulted for testing, assessment and, if required, treatment.

Alternatively, water or hydronic fluid of known quality can be brought to the site.

WARNING

Do not use automotive-type ethylene or other types of automotive glycol antifreeze, or undiluted antifreeze of any kind on the boiler water side of the system. This may result in severe boiler or tank damage. It is the responsibility of the installer to ensure that glycol solutions are formulated to inhibit corrosion in hydronic heating systems of mixed materials. Improper mixtures and chemical additives may cause damage to ferrous and non-ferrous components as well as non-metallic, wetted components, normally found in hydronic systems.

Ethylene glycol is toxic, and may be prohibited for use by codes applicable to your installation location. For environmental and toxicity reasons, IBC recommends only using non-toxic propylene glycol, and non-toxic boiler water additives of any kind.

3.1 Domestic Water Piping

See Section 8.0, Figure 6: Suggested Domestic Water Piping.

1. Drain the domestic water system.
 - Shut off the cold water supply at the main shutoff valve.
 - Open one or more faucets to relieve the pressure. Open the system drain, leaving the faucets open.
2. Position the water heater in the final location.
 - Connect the cold water supply piping.
 - Install piping onto cold inlet connection.
3. Connect to cold water supply connection using the following suggested components where applicable: A union, a heat trap, a shut-off valve, a drain valve, an expansion tank, a back flow preventer, a vacuum breaker and a filter (recommended to prevent sediment buildup).
4. Connect the domestic hot water piping.

Install piping on to hot water supply connection using a union, a heat trap, and a shut-off valve.
5. Pipe the relief valve discharge so that the discharge from the valve will exit only within 6 inches above, or at any distance below, the structural floor, and cannot contact any live electrical part. The discharge opening must not be blocked or reduced in size under any circumstances.
6. Fill the water heater tank.
 - Open all faucets to allow air to purge from the tank and piping. Remove screens on faucets.
 - Open the domestic hot water shut-off valve.
 - Slowly open the cold water inlet shut-off valve.
 - Purge all of the air from the domestic water system. Allow water to run so the tank is completely purged of any debris. Run the water long enough so that it runs clear and to change at least one tank volume change past full. Close all faucets. Reinstall all of the screens in the faucets.
 - Check the system for leaks. Repair as required.

3.2 Boiler Water Piping

See Figures in Section 8.0.

1. Determine where the boiler, the space heating, and the water heater connections should be made based on the type of piping system that is either in place, or is to be installed for a new hydronic system installation. See *Schematic drawings in Section 8.0 for direction.*
2. It is recommended that minimum size 1" pipe be used on the water heater zone to ensure adequate flow, larger sizes min 1 1/2".

3.3 Zone Circulator System

The water heater connection labeled "BOILER SUPPLY" should be piped to the boiler supply piping after the air purger and before the space heating takeoffs -

NOTE

The piping drawings in Section 8.0 of this manual are simple schematic guides to a successful installation. There are many necessary components not shown, and details such as thermal traps are left out so the drawings have greater clarity. We require that our boilers and tanks be installed by licensed and experienced trades people who are familiar with the applicable local and national codes. System design is to be completed by an experienced hydronic designer or Engineer.

The application drawing(s) shown in this manual are only part of the finished design.

It is absolutely necessary to carefully read and follow these installation instructions, and just as importantly, the installation instructions or the boiler model you are using with this water heater.

for primary/secondary systems, see primary loop space heating piping on *Figure 4: Piping Suggestion for IBC SL Series Small Boilers with Side Connections*. For parallel piping, see *Figure 2: Generic Boiler Piping Schematic – Zoned by Circulator*. Mount the water heater circulator as close as is practicable to the water heater, and make sure the flow arrow points toward the water heater. The use of shut-off valves is recommended for future service convenience.

The water heater connection labeled “BOILER RETURN” should be piped to the boiler return piping as close to the boiler as possible and after any flow control or check valves in the space heating return piping. The use of a union and a shut-off valve is recommended. The use of a check valve is required to prevent back flow through the water heater during operation of the space heating system.

3.4 Zone Valve System

It is recommended that minimum size 1” pipe and 1” full-port zone valves with a high CV be used on the water heater zone to ensure adequate flow.

The water heater connection labeled “BOILER SUPPLY” should be piped to the boiler supply piping after the air purger and grouped with the other zone supplies. The use of a shut-off valve is recommended for future service convenience.

The water heater connection labeled “BOILER RETURN” should be piped to the boiler return piping and grouped with the other zone returns. The use of a union and a shut-off valve is recommended. The use of a check valve is required to prevent back flow through the water heater during operation of the space heating system.

4.0 ELECTRICAL

⚠ DANGER

DO NOT connect thermistor sensors to “Therm” terminals on the IBC control board. An overheating hazard can result, potentially causing serious personal injury and/or property damage.

⚠ WARNING

The Thermistor temperature sensor supplied with the IBC water heater is may not to be compatible with other makes of boiler or controls, and its use may create a hazardous condition. **DO NOT USE THE IBC SENSOR WITH OTHER APPLIANCE MAKES.**

⚠ WARNING

IBC water heaters are supplied with a 10kΩ thermistor sensor to be inserted into the temperature well of the tank, and secured with a retainer clip or cap. The thermistor must be solidly affixed so as to prevent it from falling out or being pulled out. If the sensor is pulled out of the well, a continuous call for hot water will be generated, resulting in elevated tank temperatures and risk of scalding.

1. Install electric wiring and grounding in accordance with the National Electrical code and local regulations.
2. All water heaters are supplied with an aquastat for connection to most boilers. Follow the wiring instructions supplied with the aquastat and the installation instructions for the boiler the water heater is being connected to.
3. All water heaters are supplied with a 10KΩ temperature sensor that connects to the IBC control board “DWH Sensor” terminals with standard 2-wire, 18 gauge thermostat wire. For other boiler makes, an aquastat thermostat is required.
4. Reference should be made to the Installation Manual for the boiler as well.

4.1 Temperature Sensor

The Temperature Sensor supplied with the IBC Water Heater is an NTC Thermistor type with a resistance of 10,000 ohms at 25°C and β = 3892. IBC does not recommend using 3rd party supplied sensors. Compatible water temperature sensors are readily available from your IBC distributor.

The resistance of the temperature sensor varies inversely with temperature. To test, measure the temperature of the sensed environment and compare with the value derived from the measurement of the resistance (obtained by connecting a good quality test meter capable of measuring up to 5,000 kΩ (5,000,000Ω) at the controller end of the sensor lead).

To obtain a resistance reading, remove power to the boiler. The sensor leads must be disconnected from the terminal strip while taking the reading. Do not grip the sensor leads in your hands or place them on or against a conductive surface or the reading will be compromised. Place multi-meter probes onto the bare wire ends of the leads and obtain the reading. Compare the reading to the actual sensor temperature and the resistance value listed for that temperature in Table 4 (below). Do not apply voltage to the sensor (damage may result).

TEMPERATURE		RESISTANCE	TEMPERATURE		RESISTANCE
°F	°C	Ω	°F	°C	Ω
30	-1	34,558	115	46	4,184
35	2	29,996	120	49	3,760
40	4	26,099	125	52	3,383
45	7	22,763	130	54	3,050
50	10	19,900	135	57	2,754
55	13	17,436	140	60	2,490
60	16	15,311	145	63	2,255
65	18	13,474	150	66	2,045
70	21	11,883	155	68	1,857
75	24	10,501	160	71	1,689
80	27	9,299	165	74	1,538
85	29	8,250	170	77	1,403
90	32	7,334	175	79	1,281
95	35	6,532	180	82	1,172
100	38	5,828	185	85	1,073
105	41	5,210	190	88	983
110	43	4,665	195	91	903

Table 4: Temperature Sensor resistance values

4.2 Aquastat

An Aquastat is also supplied with the IBC Water Heater. The installer can choose to install either the temperature sensor as described in 4.1 or the Aquastat. The aquastat mounts in the well provided on the water heater. Electrically the aquastat will open on temperature rise (stops calling for heat when the water reaches the desired temperature) and will close when the water temperature drops below the desired temperature. The aquastat has an 8F (4.4C) fixed differential.

To install the aquastat, carefully bend the capillary tube/sensing bulb so that it is at a right angle to the back of the control. Loosen the mounting screw and carefully insert the sensing bulb into the well until the control mounts to the well head. Tighten the screw to lock in place. Connect wires (sized for the voltage being used) to the aquastat terminals. Set the aquastat to the correct temperature by adjusting the dial so that the desired temperature is at the pointer. Set the aquastat to the lowest practical setting to meet the consumer's needs. The aquastat has a maximum temperature setting of 150F. There is a hot water scalding potential if the thermostat is set too high. The addition of a scald protection device may be required either at the outlet of the water heater or at the point of use. Check with your local plumbing authority for local requirements.

5.0 OPERATION

⚠ NOTE

DHW TANK SET POINT

The temperature the end user gets from the faucet. Recommended to be no higher than 120°F to prevent scalding.

MAXIMUM SUPPLY TEMP

The highest DHW Supply Set Point temperature the boiler will allow. Should be at least 20°F higher than the DHW Supply Set Point temperature.

SUPPLY DIFF'L TEMP

The variance the control allows in the DHW Supply Set Point. Trial setting of 20°F. Set higher to reduce short-cycling around the DHW Supply Set Point.

TANK DIFF'L TEMP

The variance the control allows in the DHW Tank Set Point. A tank differential of 10°F is recommended.

⚠ CAUTION

AS A PRECAUTION:

After the water heater has reached its setpoint temperature, the installer should locate a faucet that is unprotected by an over-temperature device.

Turn the faucet on full, and allow it to run long enough to ensure the water and piping have been heated up to the discharge temperature of the tank.

Using an accurate thermometer, test the water temperature to ensure it is within plus or minus 10°F of the setpoint. If there is more deviation, the cause should be determined and corrective measures taken.

5.1 Startup

After the water heater has been plumbed and wired, and the boiler water piping is purged of air, the water heater is ready to be started. Follow the boiler installation and operating instructions to place the boiler in operation.

5.2 Temperature Adjustment

The tank sensor controls the maximum water temperature in the water heater. If it is set too high, the resulting hot water can cause painful scalding with possible serious and permanent injury. The temperature at which this occurs varies with a person's age, and the length of time in contact with the hot water. The slower response time of infants, older, or handicapped people increases the hazard for them.

It is recommended that the thermostat be set for the lowest possible temperature that satisfies your needs. This will also provide you with the lowest energy consumption and cost.

Check the water temperature at a hot water faucet soon after the tank thermostat has satisfied, and the circulator and the boiler have turned off. Adjust as needed.

Lowering the thermostat setting will not have an immediate effect on the water temperature because the stored water will have to be used and the thermostat must go through the cycle of heating cold water and satisfying at the new, lower temperature. Additional temperature checks should follow the completion of a heating cycle. Further adjustments may be required after you have used the water heater.

⚠ DANGER



- Water temperature over 125°F (52°C) can cause severe burns instantly or death from scalds.
- Children, disabled, and elderly are at highest risk of being scalded.
- See instruction manual before setting temperature at water heater.
- Feel water before bathing or showering.
- Temperature limiting valves are available, see manual.

6.0 MAINTENANCE

The water heater is intended to provide many years of reliable service. Components, such as sensors and relief valves, may be subject to failures that require service. Depending on the quality of the water supply, sediment and/or scale may coat the heating coil in the tank and reduce hot water recovery rate. Failure to use the correct procedures or parts can result in unsafe operation. The owner should arrange to have the following inspections and simple maintenance procedures done at the suggested frequencies.

1. **Boiler and Domestic Water Piping (Annual).** Check all piping for signs of leakage at the joints, unions and shut-off valves. Repair as required.
2. **Temperature and Pressure Relief Valve (Annual)**
3. **Sediment (Annual except where harsh water quality may require more frequent service).** Depending on water conditions, a varying amount of sediment may collect in the tank. Levels requiring service are indicated by a small temperature difference between the boiler supply and return lines, and a reduced recovery rate. Repeated flushing usually clears such material. As a preventive measure, water should be drawn from the drain valve until it runs clear and the installation of a water filter should be considered.
4. **Scale (Annual).** Hard water may cause scale buildup on the outside of the heating coil inside the tank. A water softener will help prevent this problem. Symptoms are identical to sediment buildup. If repeated flushing does not resolve the problem, chemical cleaning may be required. Proceed as follows:

6.1 Chemical Cleaning of the Heating Coil

1. To avoid water damage, shut off the cold water supply to the water heater.
2. Make a note of the DHW temperature control setting on the IBC control, and turn off the power to the boiler and water heater.
3. Relieve the water pressure in the tank by opening a hot water faucet. This will reduce the risk of scalding.
4. Remove the relief valve from the water heater.
5. Drain the water heater until the water is at a level equal to 3" above the thermostat well. This level will cover the coil and the thermostat.
6. Using a funnel, pour one gallon of commercial ice maker cleaning solution into the tank through the relief valve opening. Follow the instructions, cautions, and warnings supplied with the cleaning solution.
7. Turn on the power to the boiler and water heater, program the IBC control to its highest DHW temp. setting, and allow the boiler to heat the water until the control is satisfied. If the boiler control is not satisfied after 45 minutes of operation, program the IBC DHW control setting to its lowest temp.
8. Allow the heated solution to set in the tank 30 minutes.
9. Drain the tank completely using fittings and hoses, as required, to reach a drain.
10. Fill the water heater tank with fresh, cold, water and drain it completely. Repeat filling and draining at least three (3) times to flush all of the cleaning solution from the tank.
11. Reinstall the relief valve and the drain piping.
12. Open the cold water supply and fill the tank with water. Purge the air from the tank and the piping by opening the cold and hot water faucets in the house.
13. Return the IBC DHW control setting to the temperature noted in Step 2.

7.0 TROUBLESHOOTING

SYMPTOM	DIAGNOSIS	REMEDY
WATER AT FAUCETS TOO HOT	DHW temperature setting too high	<ul style="list-style-type: none"> Reduce the DHW Tank Set Point temperature
	DHW temperature sensor giving false reading	<ul style="list-style-type: none"> Sensor is not fully inserted into the well Sensor giving incorrect resistance reading Sensor connected to IBC Therm terminals instead of DHW Sensor terminals Improper 3rd party sensor installed in well
WATER AT FAUCETS TOO COOL	DHW temperature setting too low	<ul style="list-style-type: none"> Increase the DHW Tank Set Point temperature
	Boiler Maximum Supply Temp. setting too low	<ul style="list-style-type: none"> Make sure the Maximum Supply Temp. setting is at least 10°F higher than the DHW Supply Setpoint PLUS 1/2 of the Supply Diff'l Temp setting.
NO HOT WATER AT FAUCETS	Boiler does not operate	<ul style="list-style-type: none"> Ensure boiler power is on Ensure the boiler is programed for DHW and the water temperatures are set properly Check the tank temperature on the IBC screen, Open or Short + sensor or wiring issue
	Water Heater Circulator does not operate	<ul style="list-style-type: none"> Follow steps for Boiler does not operate Ensure the pump relay is closed and supplying power to the pump Ensure the zone valve is open and the end switch is closed calling for heat Check wiring connections at the circulator Measure voltage at the circulator during a call for heat, should see 120VAC +/- 12VAC If power is at the circulator and connections are correct, replace circulator
	Water heater zone valve does not open	<ul style="list-style-type: none"> Follow steps for Boiler does not operate Check for 24VAC at the zone valve while there is a call for heat, if correct voltage is available and connections are good, replace the zone valve.
	Tank sensor open, short, or mis-wired	<ul style="list-style-type: none"> Ensure the tank sensor is connected to the correct terminals and the wires are properly attached to the terminal strip and the sensor is properly attached to the wiring at the tank Disconnect the sensor wires from the terminal strip and measure the resistance in Ohms across the 2 sensor wires. Compare this value to the chart and the actual tank temperature. Repeat this test for the sensor only and compare the results. Check/replace the wire from the boiler to the sensor or replace the sensor

8.0 SCHEMATICS

NOTE

Full sized and more detailed application drawings can be downloaded from our web site.

www.ibcboiler.com

NOTE

When using the sequential load feature of the IBC boiler, attention must be paid to the operation of system components in order to ensure they are compatible.

Many air handlers (fan coils) for instance have a thermostat connection that will energize an internal relay to operate the air handler circulator and its fan on a call for heat. This may result in operation of these components when other loads are running at a higher priority, resulting in cold air blowing, or robbing heat from another load.

Some wiring alteration may be required to divorce both of these functions from thermostat control in favour of more effective control from the IBC boiler.

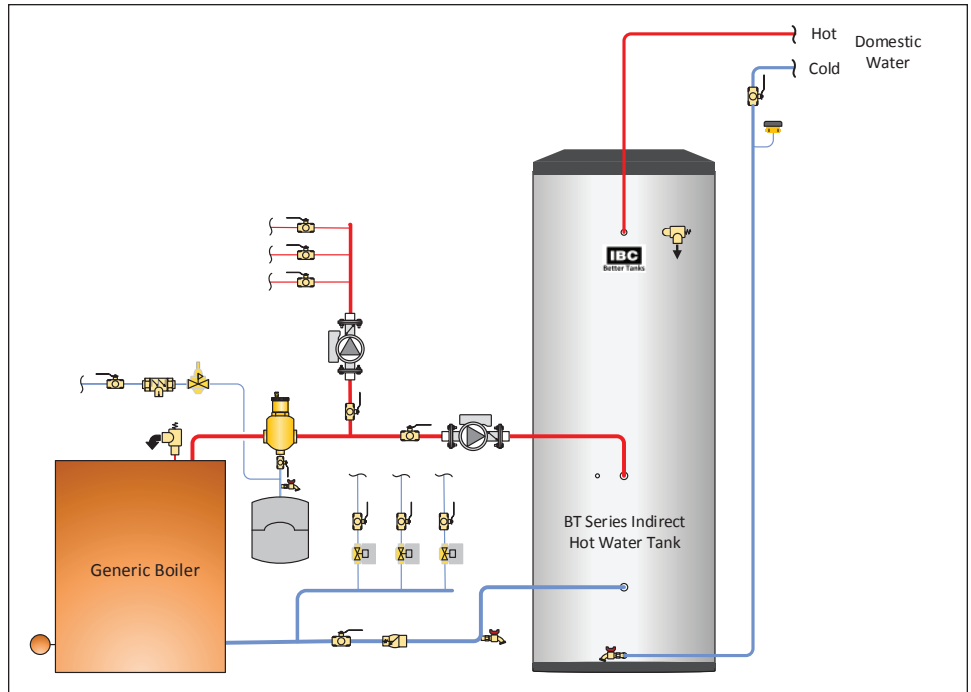

Figure 2: Generic Boiler Piping Schematic – Zoned by Circulator

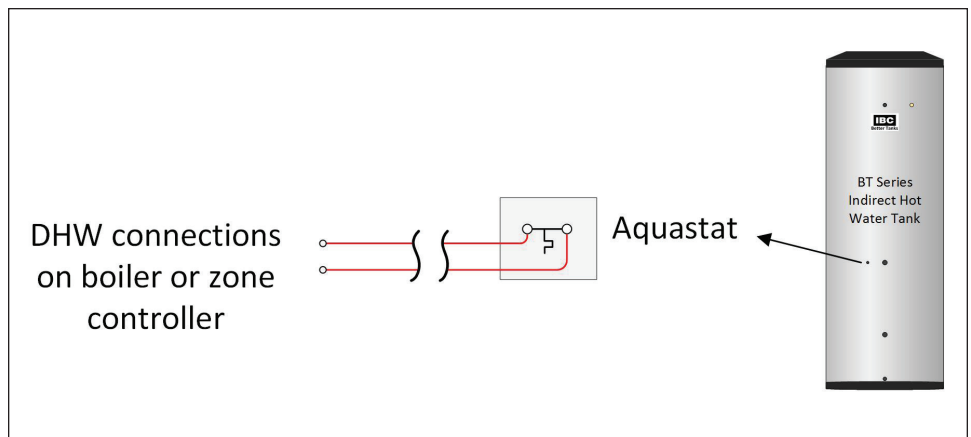

Figure 3: Generic Aquastat Wiring – Aquastat Opens on Temperature Rise

NOTE

When using zone valves in a multi-zone heating system, careful consideration must be taken to ensure that flow rates do not decrease below the boiler's rated minimum flow requirement. Bypass arrangements (pressure activated bypass, three way valves, etc.) may be required to ensure adequate flow under low load conditions.

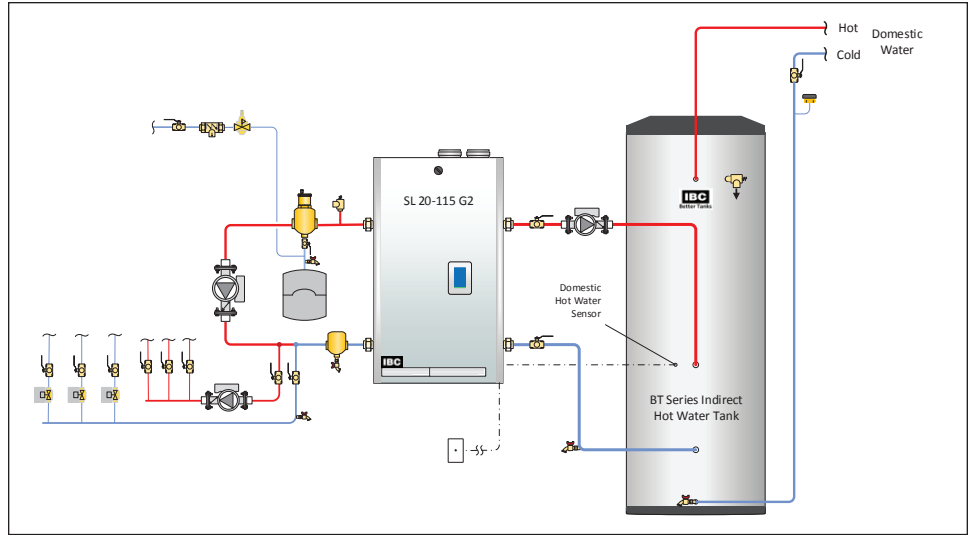

Figure 4: Piping Suggestion for IBC SL Series Small Boilers with Side Connections

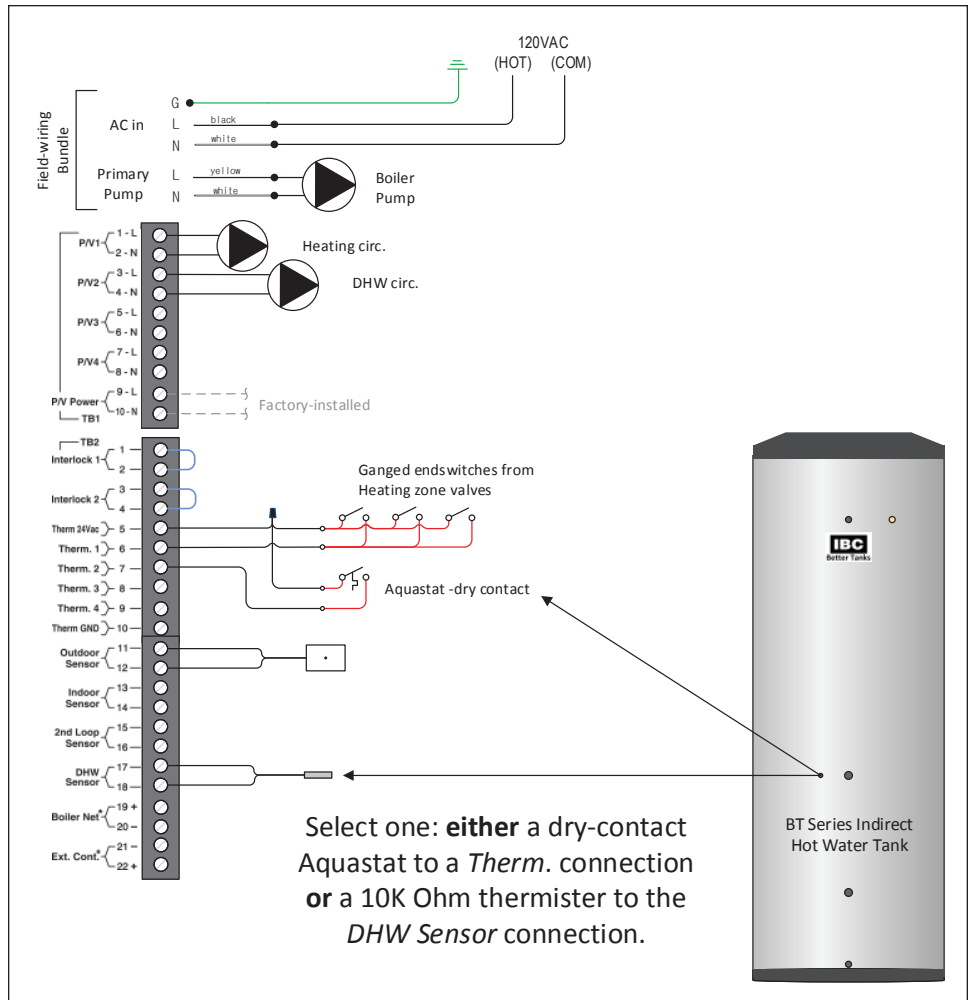

Figure 5: Wiring Suggestion for IBC Boilers

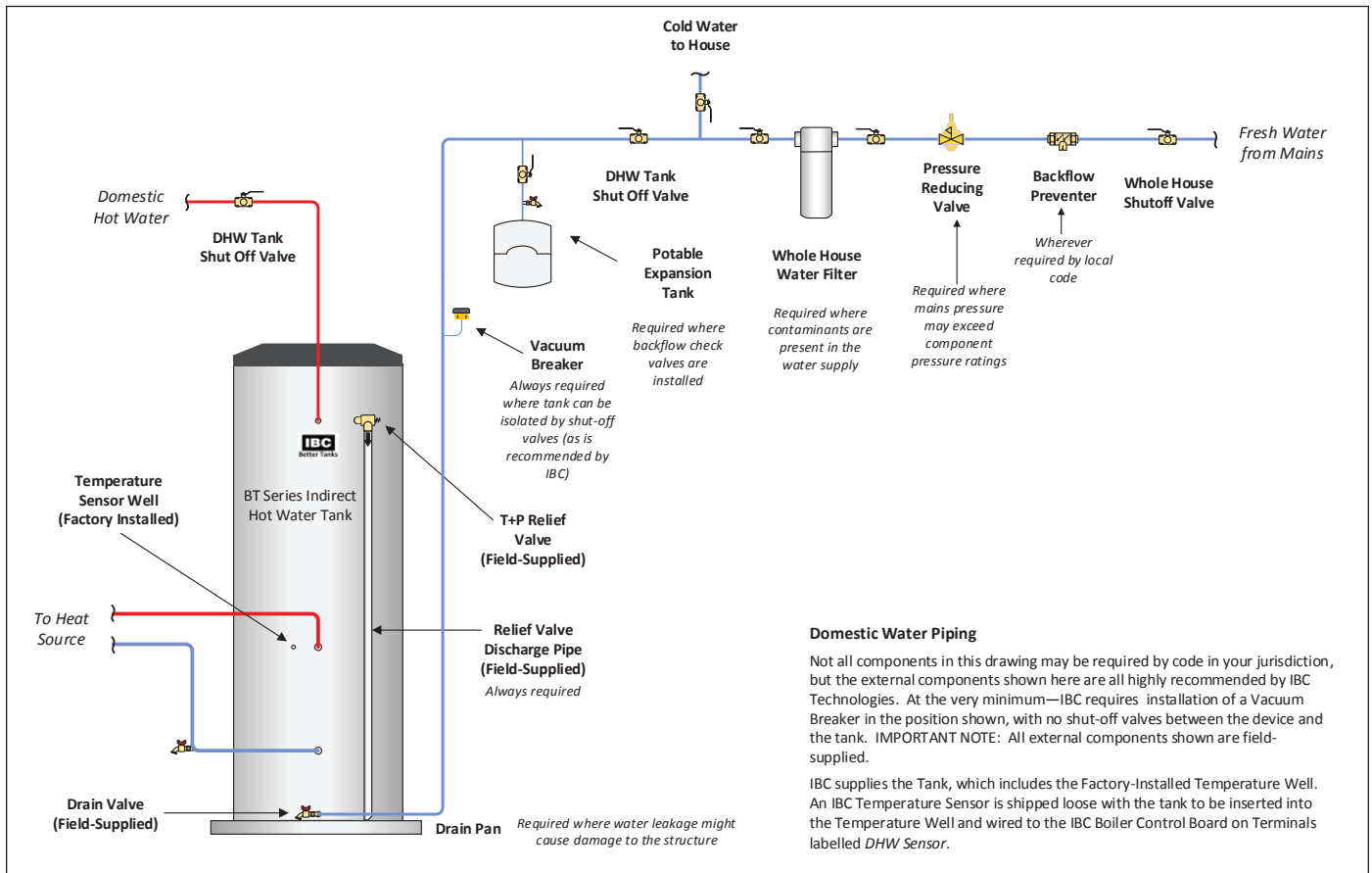

Figure 6: Suggested Domestic Water Piping

SERVICE RECORD

DATE	LICENSED CONTRACTOR	DESCRIPTION OF WORK DONE

REVISION HISTORY

R1 (JULY 2015)	Initial release
R2 (SEPTEMBER 2015)	Certified release
R3 (JUNE 2016)	Updates to Dimensions and Capacities table; updates to Ratings table

IBC Technologies Inc.

8015 North Fraser Way
Burnaby, BC
Canada V5J 5M8

Tel: 604.877.0277

Fax: 604.877.0295

www.ibcboiler.com

120-221A1-R3

June 2016

© IBC Technologies Inc. 2016